

LOCK SWITCH

HRL LOCK SWITCH

ELECTRICAL & MECHANICAL SPECIFICATION

Switch Rating:	1A @24V ac/dc	Life:	>10,000 Cycles
Proof Voltage:	750 Vac (Initial)	Lock Type:	5 Disc
Insulation Resistance:	>999MΩ @ 500Vdc (Initial)	Operating Temperature:	-20°C to +65°C
Contact Resistance:	<20mΩ (Initial)	Lock Housing:	Zinc Alloy Bright Cr Plated
Contact Material:	Brass CZ108, Ag Plated	Moulding Material:	Polyamide 6.6 G.F. V0 Rated

FEATURES

Reinforced module to lock connection for higher vibration or weight applications

- | | | |
|---------------------------|---|---|
| Front assembly | 2 keys per switch | Moulded bezel available for parallel lock headed version (SRL02101 see below) |
| Single or Double pole | Up to 200 differ key combinations available | Made In UK |
| Rear panel depth - <30mm | Keys are double entry (can be inserted into lock either way up) | |
| Max panel thickness 4.5mm | | |

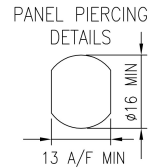

SINGLE POLE LOCK SWITCH

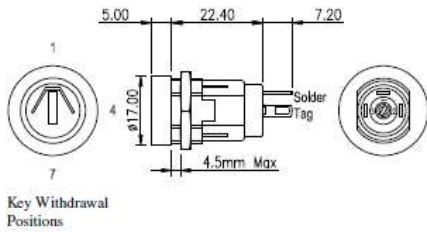

PARALLEL LOCK HEAD 90° INDEXING

BASIC PART No.	TOTAL MOVEMENT	INDEXING	KEY WITHDRAWAL POSITIONS	SWITCH CONFIGURATION
HRL-5-A	90°	90°	1,4	
HRL-5-B	90°	90°	1 ONLY	
HRL-5-C	180°	90°	1,4,7	
HRL-5-R	180°	90°	1,4	
HRL-5-S	180°	90°	1 ONLY	
HRL-5-N	180°	90°	1,4,7	

SINGLE POLE LOCK SWITCH

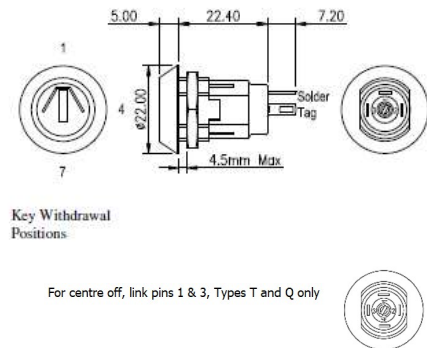

TAPERED LOCK HEAD 90° INDEXING

BASIC PART No.	TOTAL MOVEMENT	INDEXING	KEY WITHDRAWAL POSITIONS	SWITCH CONFIGURATION
HRL-5-D	90°	90°	1,4	
HRL-5-E	90°	90°	1 ONLY	
HRL-5-F	180°	90°	1,4,7	
HRL-5-V	180°	90°	1,4	
HRL-5-W	180°	90°	1 ONLY	
HRL-5-P	180°	90°	1,4,7	
HRL-5-T	180°	90°	1,4,7	
HRL-5-Q	180°	90°	4 ONLY	

DOUBLE POLE LOCK SWITCH

Parallel lock head 60° indexing

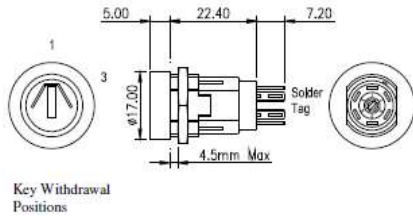

PARALLEL LOCK HEAD 60° INDEXING

BASIC PART No.	TOTAL MOVEMENT	INDEXING	KEY WITHDRAWAL POSITIONS	SWITCH CONFIGURATION
HRL-5-J	60°	60°	1,3	
HRL-5-K	60°	60°	1 ONLY	

DOUBLE POLE LOCK SWITCH

Tapered lock head 60° indexing

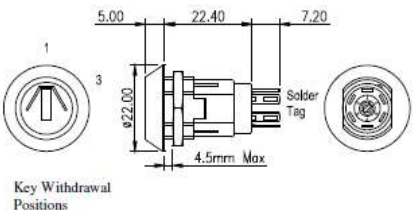

TAPERED LOCK HEAD 60° INDEXING

BASIC PART No.	TOTAL MOVEMENT	INDEXING	KEY WITHDRAWAL POSITIONS	SWITCH CONFIGURATION
HRL-5-L	60°	60°	1,3	
HRL-5-M	60°	60°	1 ONLY	

OPTIONAL MOULDED BEZEL

FOR PARALLEL LOCK HEADED VERSIONS _

PART NUMBER SRL02101

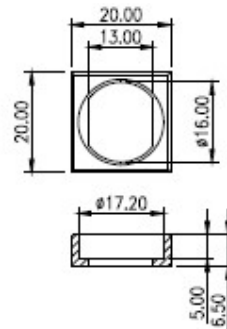

HRL ORDERING CODE

H R L - 5 - [] - [] - 2

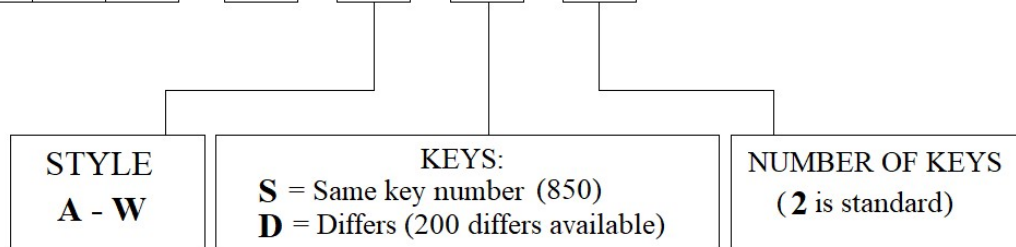

BELTRONICA

NUEVA DIRECCIÓN / NEW ADDRESS

Avenida de Somosierra, 22 - Naves E 6 y 7 - P. E. Inbisa I

San Sebastián de los Reyes - ES 28703 - Madrid

Tel / Phone: +34 916 381 331 - comercial@beltronica.es